

# EDSR100

## DIGITAL VIDEO RECORDER



## INSTRUCTION MANUAL

Before installing and using this unit, please read this manual carefully.  
Be sure to keep the manual handy for later reference.



*CCTV Products*

**C**onsistent™  
**C**ommitment  
**T**o  
**V**alue

## Safety Warning

---

**WARNING**

TO REDUCE RISK OF FIRE OR ELECTRIC SHOCK,  
DO NOT EXPOSE THIS APPLIANCE TO RAIN OR MOISTURE.

**CAUTION**

DO NOT REMOVE COVER. NO USER SERVICEABLE PARTS INSIDE.  
REFER SERVICING TO QUALIFIED SERVICE PERSONNEL.

**WARNING:**

This equipment has been tested and found to comply with the limits for a Class "A" digital device, pursuant to part 15 of the FCC Rules. These limits are designed to provide reasonable protection against harmful interference when the equipment is operated in a commercial environment. This equipment generates, uses and can radiate radio frequency energy and, if not installed and used in accordance with the instruction manual, may cause interference to radio communications. Operation of this equipment in a residential area is likely to cause harmful interference in which case the users will be required to correct the interference at their own expense.

Changes or modifications not expressly approved by the party responsible for compliance could void the user's authority to operate the equipment.

This Class A digital apparatus meets all requirements of the Canadian Interference Causing Equipment Regulations.

**Notice:**

The information in this manual was current when published. The manufacturer reserves the right to revise and improve its products. All specifications are therefore subject to change without notice.

## Table of Contents

---

---

	Page
<b>Front Panel Controls.....</b>	<b>4 . 5. 6.</b>
<b>Instant Recording Controls</b>	
Normal & Instant Record Setting Menu.....	7.
<b>Normal Playback..... 8. 9. 10. 11. 12.</b>	
Normal Playback.....	
Search Playback.....	
<b>Copying Images ..... 13. 14. 15.</b>	
Still Image Copy.....	
Copy to Movie File.....	
<b>Remote Controller.....</b>	<b>16.</b>
<b>Appendix-A/Time Lapse Mode Recording Time..... 17.</b>	
Recording with and 80 GB HDD.....	
<b>Appendix-B/ Security Lock setting.....</b>	<b>18.</b>
<b>Technical Help.</b>	
<b>Power Failure Or Power Disruption Reset / Reboot Procedure.....</b>	<b>19.</b>

2. Front Panel Controls

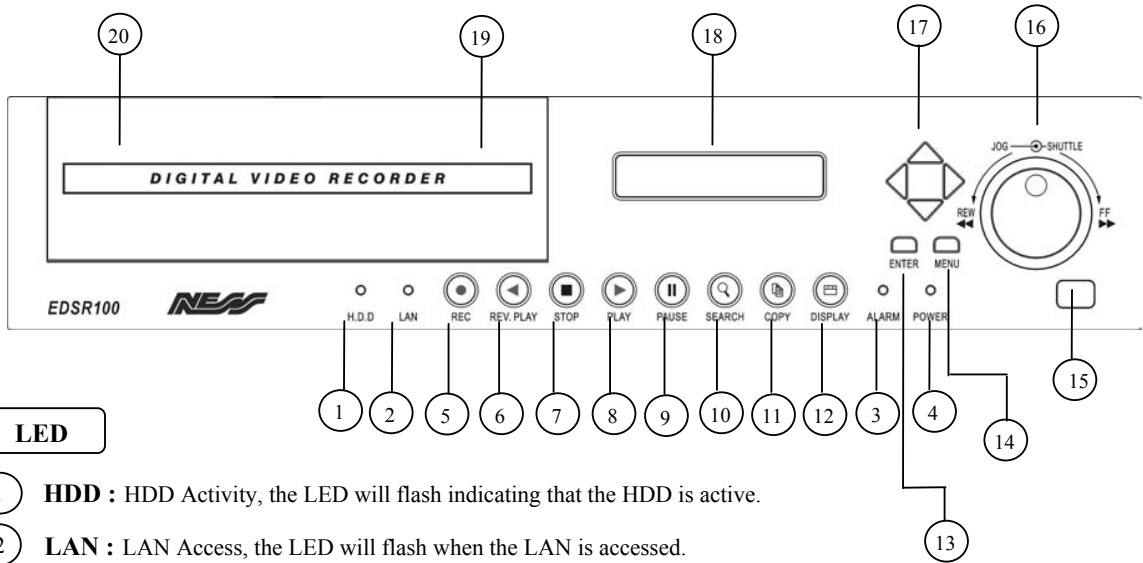

**LED**

- ① **HDD** : HDD Activity, the LED will flash indicating that the HDD is active.
- ② **LAN** : LAN Access, the LED will flash when the LAN is accessed.
- ③ **ALARM** : The LED will flash when an alarm occurs.
- ④ **POWER** : Indicates Power is ON.

**Keys**

- ⑤ **REC** : Press this Button to start recording.
- ⑥ **REV. PLAY** : Reverse Play Back. The playback speed is shown on the LCD display, and press ▲▼ to change the speed if necessary.
- ⑦ **STOP** : Press this Button to stop Recording and Playing Back.
- ⑧ **PLAY** : Playing Back. The playback speed is shown on the LCD display, and press ▲▼ to change the speed if necessary.
- ⑨ **PAUSE** : Press this Button to pause the Video playback picture.
- ⑩ **SEARCH** : Press this Button to enter the Search Playback Menu.
- ⑪ **COPY** : Press this Button to start copying still pictures or video stream into Compact Flash card.
- ⑫ **Display** : Press this Button ON/OFF to display Time Date & HDD Specifications..

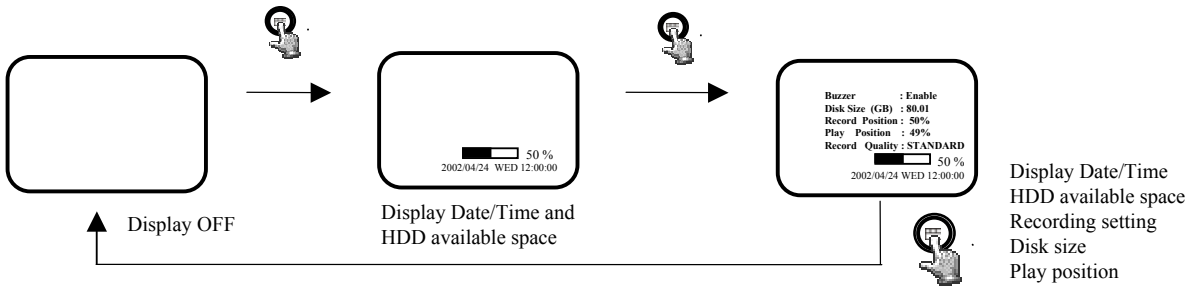

## Front Panel Control

---

---

13  **ENTER** : Press this Button to confirm the selection or data changed.

14  **MENU** : Press this Button to enter the Installation Setup menu.  
**Note: This area is reserved for the Technician, and should not be ACCESSED by the user.**

15  **Remote Control** IR Remote receiver

16  **Jog and Shuttle Dial**

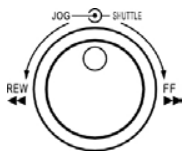

**Shuttle Dial** : In Playback mode, turn the External Shuttle dial Clockwise or Anti-Clockwise to fast forward/rewind the video.  
In Pause mode, turn shuttle dial to forward/rewind the pictures slowly.

**Jog Dial** : In Pause mode, turn the internal Jog dial forward/backward the picture by one field. In Menu mode, please refer to page 13 “ Menu Flow”

17  **Up/ Down** : (1) In Menu mode, press these Buttons Up or Down to change data.  
(2) In Record/Playback mode, press these buttons for Playback & Record speeds.

 **Left/ Right** : In Menu mode, these buttons are used to move the cursor.

18 **LCD Display**

2002/04/24 12:00:00	SYS LOAD 002 HR
------------------------	--------------------

Switch on the power, “system loading” will be shown for 10 seconds, both on the LCD display & Main monitor screen.

2002/04/24 12:00:00	STANDARD 002 HR
------------------------	--------------------

In Standby mode, the date/time is the current date/time and shows the quality and rate setting for normal recording.

2002/04/24 12:00:00	RECORD . 002 HR
------------------------	--------------------

In Record mode, the date/time is the current date/time and will display RECORD and current recording rate/speed.

2002/04/24 12:00:00	PLAY > 002 HR
------------------------	------------------

In Playback mode, the date/time is the playback date/time and displays PLAYBACK and current playback rate/speed.

19 **Compact Flash Card Slot:** Compact Flash Card insertion bay.

20 **Hard Disk Tray:** Hard Disk holder for HDD.

---

---

## 7. INSTANT RECORDING

- Press the Record Button to start the recording.



REC

Press the REC button to commence recording.

- The recording rate and recording quality are set in the Record Set menu
- “RECORD” appears in the operating display
- “RECORD” appears in the LCD display. (Press the DISPLAY button to show the message on the screen)

Video out



LCD Display

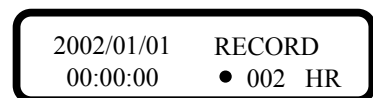

STOP

Press the Stop Button to stop recording.

When the Hard Drive is full, the EDSR will **Stop recording automatically** or **Overwrite** from the beginning of the HDD, as programmed. Default setting = to Overwrite once Full.

## 8. NORMAL PLAYBACK

### (1) Playback



PLAY button : Starts Playback of video.



REV.PLAY button: Starts reverse playback of video.

### (2) STOP



STOP button : stops recording or playing.

### (3) Fast Forward/Reverse Playback



PLAY button to start playback of video..

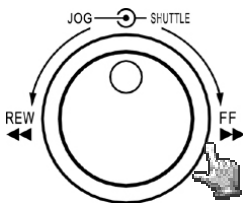

Turn the shuttle dial clockwise and fast forward playback starts.  
The speed will be shown on the LCD and the right upper corner of the screen.  
>> 2, 4, 6, 8, 16, 32, 600X

Turn the shuttle dial counterclockwise and fast reverse playback starts.  
The speed will be shown on the LCD and the right upper corner of the screen. .  
<< 2, 4, 6, 8, 16, 32, 600X

## (4) Slow Forward/Reverse Playback



PAUSE button: Press to freeze playback video picture.

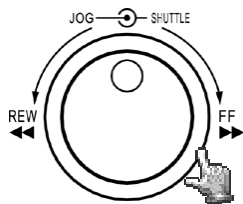

Turn the shuttle dial clockwise and slow forward playback starts.  
The speed will show on the LCD and the right upper corner of the screen.  
>> 1/2, 1/4, 1/6, 1/8, 1/10, 1/16, 1/32

Turn the shuttle dial counterclockwise and slow reverse playback starts.  
The speed will show on the LCD at the the right upper corner of the screen. .  
<< 1/2, 1/4, 1/6, 1/8, 1/10, 1/16, 1/32

## (5) Frame/Field advance Forward/Reverse



PAUSE button: Press to freeze the picture.

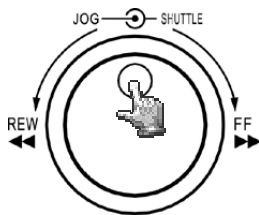

Turn the jog dial clockwise to advance the still image Frame/Field by Frame/Field .

Turn the jog dial counterclockwise to rewind the still image Frame/Field by Frame/Field .

The Frame/Field speed will increase if the jog dial is turned quickly.

## SEARCH & PLAYBACK



### (10) Segment Search Playback

Note: Press the STOP Button to Stop RECORDING before Searching for any Video Playback.



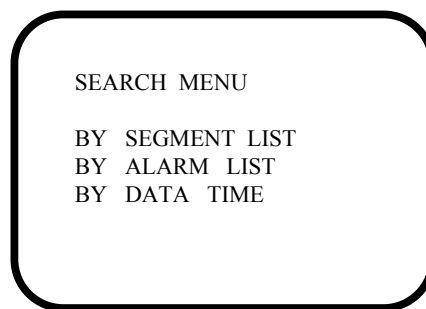

Press the SEARCH Button to enter the Search menu.

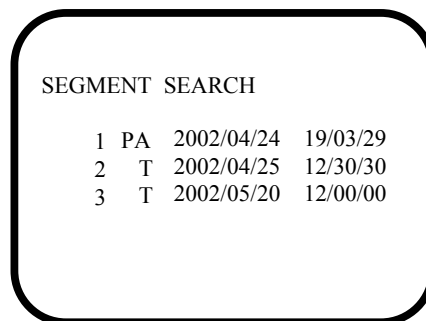

Using the   keys to move the cursor to Highlight over the BY SEGMENT LIST menu , and press the ENTER Button to select next menu page.



PA : PRE-ALARM RECORD  
T : TIMER RECORD

Press   key to move the cursor to Highlight the segment required for playback, Now Press the Enter Button to select the segment and to commence playback, ( Playback commences automatically upon pressing the Enter Button.. Playback has commenced and control of Speed, Still/Pause, Reverse, Stop can be achieved by use of the Jog Dial Control Ring, and Playback command Buttons.

## (11) Alarm Search Playback

Note: Press the STOP Button to Stop RECORDING before Searching for any Video Playback.



SEARCH

Press the SEARCH Button to enter the Search menu.

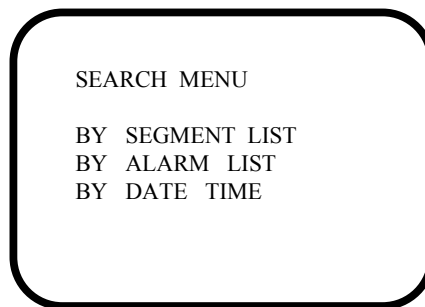

Using the ▼ ▲ keys to move the cursor to Highlight over the BY ALARM LIST Title, and press the ENTER Button to select next menu.

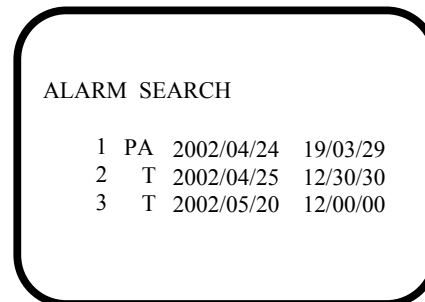

PA : PRE-ALARM RECORD  
T : TIMER RECORD

Press ▼ ▲ key to move the cursor to Highlight the segment required for playback, Now Press the Enter Button to select the segment and to commence playback, ( this is automatic upon pressing the Enter Button..

Playback has commenced and control of Speed, Still/Pause, Reverse can be achieved by use of the Jog Dial Control Ring, and Playback command Buttons. Note, only the Alarm Duration of the event selected shall be display and stop, use reverse and forward play commands to view entire video from start to finish.

## (12) Date/Time Search Playback

Note: Press the STOP Button to Stop RECORDING before Searching for any Video Playback.



Press the SEARCH Button to enter the Search menu

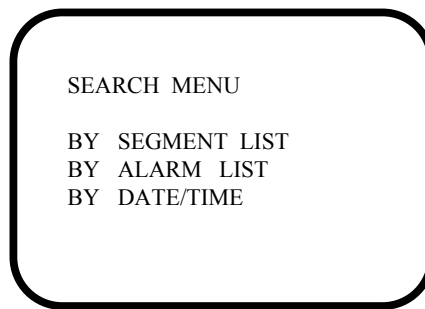

Using the ◀ ▶ Buttons to move the cursor to Highlight over the Year or Month or Day or Hour or Minute or Seconds and use the ▼ ▲ Up and Down buttons to adjust the decimal value required.

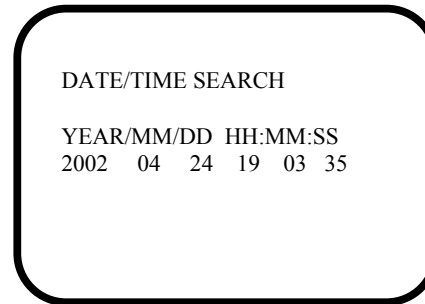

Press ◀ ▶ button to move the cursor.

Press ▼ ▲ button to increase/decrease the data.

Press the Enter Button and playback will be searched and commence automatically, based on the Date and Time shown..

**Notice:** If no match is found by the ESR search, to the Specified Date & Time entered, video playback will commence upon the nearest prior recording found.

### 13. COPY

Insert a Compact Flash card into the Compact Flash bay behind the HDD cover.

When inserting the Compact Flash card, make sure that the direction of insertion is correct.

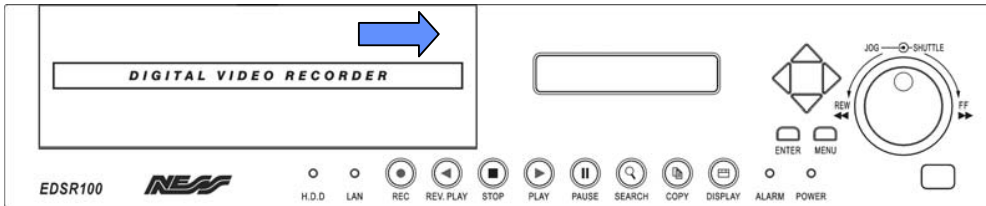

#### STILL IMAGE COPY



Press the **PLAY** button to start play back.



Press the **PAUSE** button to freeze the picture required for copying..

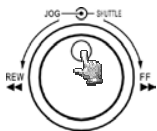

Turn the jog dial clockwise or counterclockwise to the desired image of choice.



Once your desired image is display and Paused ,  
Press the **COPY** button.

“ Copying ...” will be shown on the monitor screen during this process.

“ Success” will be shown on the screen once the file has been transferred successfully into the Compact Flash Card.

**Notice:** Copied images are stored as a single picture.  
Copied files are saved as .JPG file.

## 14. COPY the MOVIE FILE



**PLAY**

Press the **PLAY** button to start playback.



**COPY**

Press the **COPY** button and the copy menu will appear with command prompts..

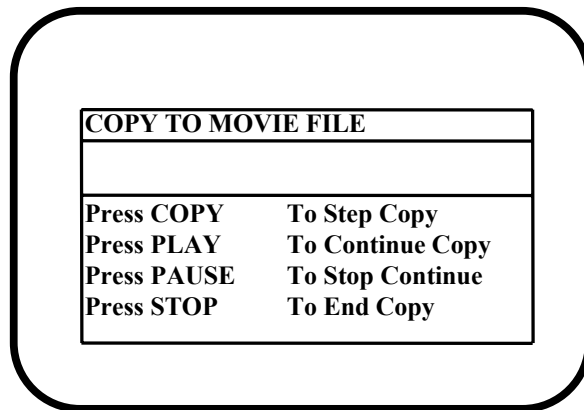

**PLAY**

Press the **PLAY** button to continue Copying a Movie File.

**COPY the MOVIE FILE Cont.:**



**PAUSE**

**Press the PAUSE button to stop movie copying.**



**STOP**

**Press the STOP button to end new movie copying.**

**Note:** Copied images are stored as a movie picture.  
Copied files are saved as .MOV file.

Use QuickTime to play the retrieved .MOV files.

You may download QuickTime free at **[www.apple.com](http://www.apple.com)**  
The playback version for QuickTime is freeware.

## 16. Remote Controller

(Optional)

- The remote controller is an accessory to enhance the handy operations of EDSR100 (Figure 1). You can operate all functions settings via the IR remote control.

The effective distance is up to 10 meters without any obstacle. The keypad functions are identical to the front panel button controls.

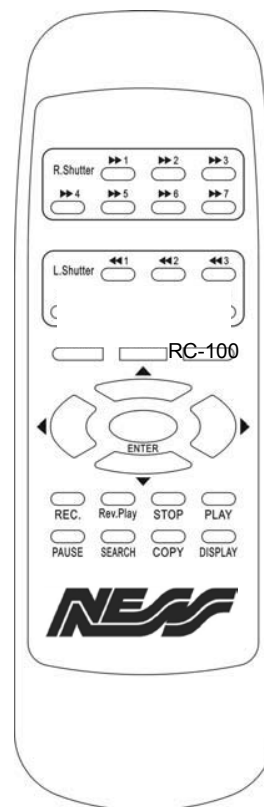

Figure 1

## Time Lapse Mode Recording Time Table

17. When Recording with an 80-GB HDD  
(Estimated with typical image-low noise level)

Lower : 15 kB  
Low : 20 kB  
Basic : 25 kB  
Standard: 30 kB  
High : 35 kB  
Superior : 40 kB

PAL		(system storage:80GB)					
Recording Speed (Hour)	Recording Rate (field/Sec)	PICTURE QUALITY					
		LOWER	LOW	BASIC	STANDARD	HIGH	SUPERIOR
3	50	29H	22H	17H	14H	12H	11H
6	16.667	88H	66H	53H	44H	38H	33H
12	10	148H	111H	88H	74H	63H	55H
24	5.556	266H	200H	160H	133H	114H	100H
48	2.941	503H	377H	302H	251H	215H	188H
72	2	740H	555H	444H	370H	317H	277H
96	1.515	977H	733H	586H	488H	419H	366H
168	0.877	1689H	1266H	1013H	844H	724H	633H
480	0.311	4763H	3572H	2858H	2381H	2041H	1786H
720	0.207	7156H	5367H	4294H	3578H	3067H	2683H
960	0.156	9646H	7122H	5698H	4748H	4070H	3561H

For Smaller or Larger Hard Drive Storage ranges, Contact Your NESS CCTV DEALER

---

---

## SECURITY LOCK SETTING



REC

Press the REC Button 5 times during record mode, this will lock all Buttons from Control on the front panel.



STOP

When you Press STOP Button, the system will ask for the password.  
By entering the correct password, all buttons will be unlocked for use.

### Front panel Button / Number configuration.

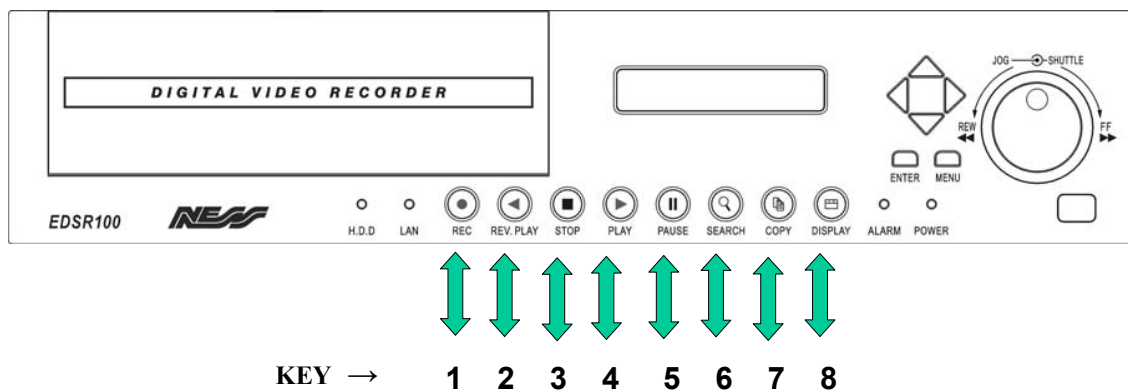

The Default: **PASSWORD = 888888**

By pressing the Display button ( 8 ) six times the system will UNLOCK.

**NOTE: Keep this Page in a Safe Location, away from NON Users of the System**

---

---

## **TECH HELP: POWER FAILURE REBOOT / RESET Procedure.**

Due to the sensitivity of any Digital Recorder or Computer utilizing an Hard Drive it is vital to ensure that the system is maintained by proper power connection. This can be achieved by providing a stable power supply ( 240VAC ).

If, Mains power is not stable and your site is affected by power black outs or fluctuations, then it is highly recommended that you provide the EDSR system a suitable Uninterrupted Power Supply ( UPS ). This will ensure correct and stable operation of your video recordings to the Hard Drive and also ensure that your investment towards an NESS CCTV system is secured, resulting in many trouble free years of operation.

If your system has experienced an power black-out and the system does not resume operation, which was caused by a high voltage start up ( brown out ), then the following procedure should be performed.

- 1) Turn Off the EDSR100, ( Switch at Rear of Unit ).
  
- 2) Open the Hard Drive Cover and disconnect the Hard Drive by turning the Hard Drive Key Lock OFF.
  
- 3) Turn ON the EDSR100, wait for the LCD screen to display normal time date, status information.
  
- 4) Turn ON the Hard Drive Lock, wait for the ( System Loading ) indication on the Monitor to stop flashing and disappear, Now Press REC to resume normal recording.

**The System is now Reset and functioning properly.**

If, this reboot procedure does not work first time, repeat all 4 steps,

If the system after repeating these steps does not reboot,

***Call your NESS DEALER for Service attention.***

